

P 40

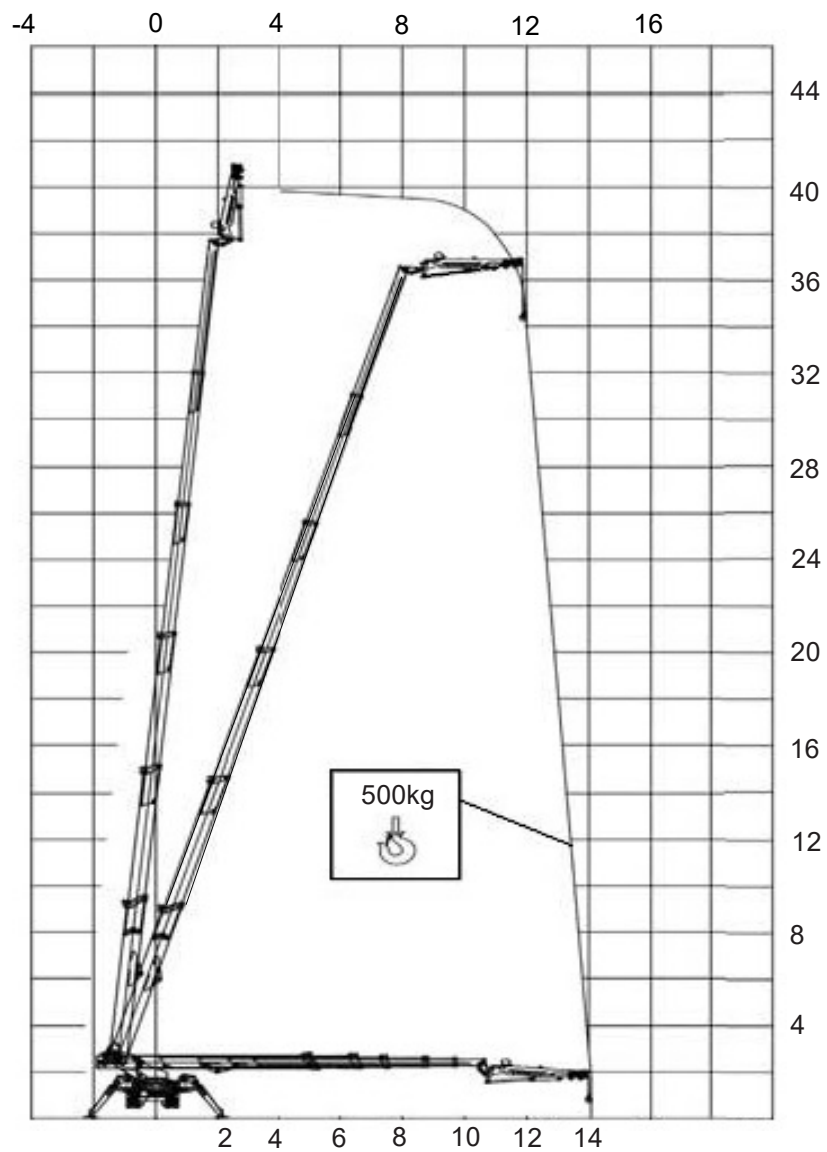

Geschäftssitz Bilten
Linth-Escherstrasse 19e
8865 Bilten

Standort Schmerikon
Allmeindstrasse 9
8716 Schmerikon

Standort Zürich
Aegertstrasse 13
8305 Dietlikon

Mobilkran
Tel. 043 399 45 00

Transporte
Tel. 055 619 65 19
www.feldmann-kran.ch



40m ↑
14m →
500kg ⤴

Minikran Pallazani XTJ 43





Einsatzbeispiele für Miniraupenkran

- ✓ Stahl- und Metallbau
- ✓ Fenstermontagen
- ✓ Glasarbeiten mit Glassauger
- ✓ Betonrückbau im Gebäude
- ✓ Gartenarbeiten
- ✓ Elementbau
- ✓ Wintergartenbau
- ✓ Fassadenbau
- ✓ Lüftungs- und Apparatebau
- etc.



BI-ENERGY

 Diesel
32,5 kW

 Single-phase
Electric motor
230VAC - 2,2 kW

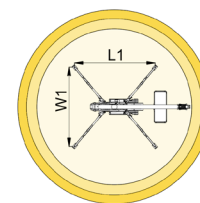
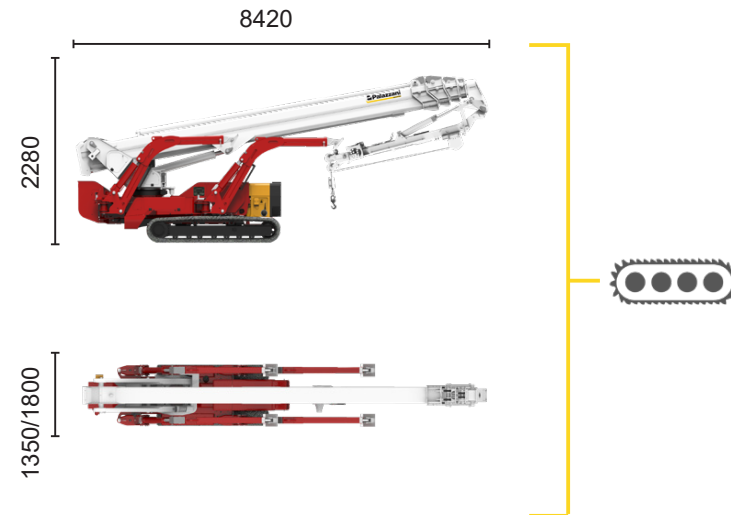

L1 | W1
5945 mm | 5230 mm

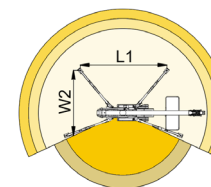

L1 | W2
5945 mm | 4435 mm

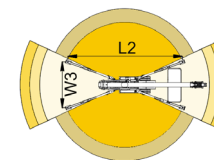

L2 | W3
7095 mm | 3640 mm



40.0 m



14.0 m



500 kg



3.64 - 5.23 m



23°



38°



2 km/h



10900 kg



75 kN



3,51 kN/m²